

MATERIAL: DUCTILE IRON / STEEL / ALUMINUM
VITON

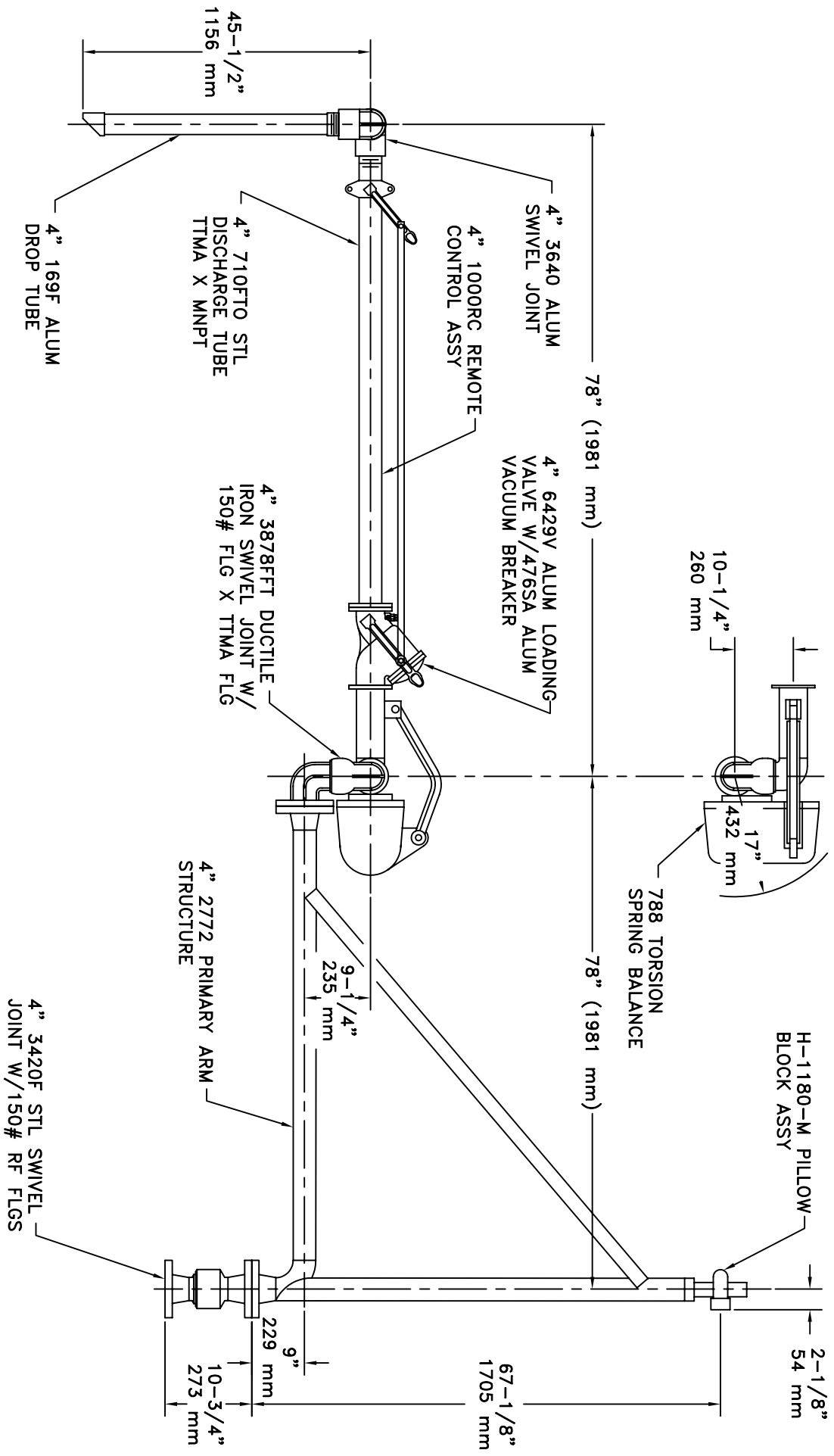

4" OPW B32RF LIQUID LOADER



ARM IS DESIGNED FOR PRODUCT RETENTION TO POINT OF VALVE