

Installation Manual

Part Number: - M1040

Revision: - 1 - DRAFT



Automatic Vehicle Identification

DFS *Worldwide Brands*



NOTE: Before you use this manual, make sure you have the most recent revision. Look at the revision of this document to make sure it agrees with the most current revision found at <http://www.opwglobal.com/opw-fms/tech-support/manuals-how-to-videos>. Download the latest revision if necessary.



OPW Fuel Management Systems is a part of Dover Fueling Solutions.

Copyright Information

© 2021 Dover Fueling Solutions. All rights reserved. DOVER, the DOVER D Design, DOVER FUELING SOLUTIONS, and other trademarks referenced herein are trademarks of Delaware Capital Formation, Inc./Dover Corporation, Dover Fueling Solutions UK Ltd. and their affiliated entities.

Contact OPW Fuel Management Systems

Visit us at <https://www.doverfuelingsolutions.com/>, or contact us at:

Call 1-877-OPW-TECH (877-679-8324)

For calls outside US and Canada, call +1-708-485-4200

Monday through Friday, 7 a.m. to 6 p.m., US CST

For technician registration, see

<http://www.opwglobal.com/opw-fms/tech-support/technician-registration>

For in-depth training through OPW University, see

<http://www.opwglobal.com/opw-fms/tech-support/training-certification>



Table of Contents

Section 1 Introduction	5
1.1 General Safety for Installations.	5
1.2 Security Features	6
1.3 Safety Warnings	7
1.4 Hazardous Areas	8
1.4.1 NFPA/NEC – Class I, Div. 1 & Div. 2	8
1.4.2 Installation Requirement	9
1.5 FCC Compliance	11
Auto Vehicle Identification Component Installation	12
Section 2 Radio Frequency Nozzle	13
2.1 Battery Assembly	13
2.1.1 Replacement Battery Kit (OPW-FMS P/N 48-0216)	14
2.2 RFN Installation on OPW/ZVA Nozzles	16
2.2.1 Installation on OPW7H / VZA25 Nozzles	16
2.2.2 Installation on OPW11A Nozzles	17
2.3 Split-Design RFN (SRFN) – Installation on OPW11A and OPW7H Nozzles	19
2.3.1 SRFN Components	19
2.3.2 SRFN Assembly	20
2.4 Boot Installation	27
2.4.1 Boot Installation with Pre-Installed RFN	27
Section 3 Tag Installation	29
3.1 Flush Mount Fuel Inlets	29
3.2 Capless Fuel Inlets	31
3.3 Buses and Trucks	32
3.3.1 Short Neck Fuel Inlets	32

3.3.2 Fuel Inlet Tag with Holder	33
3.3.3 Truck Tag	34
3.3.4 Long Neck Fuel Inlets	34
3.3.5 Long Neck Fuel Inlets Less than 45 mm (1.77 in.)	37
Section 4 Tag Tuning Procedure	39
Section 5 Vehicle Identification Device Installation	44
5.0.0.1 Installation Conditions	45
5.1 VID Wiring	46
5.2 Long Range Antenna Installation	46
Section 6 AVI Wire Harness with GPS Odometer Sender (GOS)	48
6.1 GOS Antenna Installation	48
6.1.1 Adhesive Installed Antenna	48
6.1.2 Roof Installed Antenna	49
6.2 GOS Control Module Installation	49
Section 7 Auto Vehicle Identification System Power	50
7.1 Fuse Holder	50
7.2 Power Supply Connections	51
7.2.1 Light-Duty Vehicles	51
7.2.2 Trucks and Heavy-Duty Vehicles	52
Section 8 VID Wiring with 20-1725 GOS Cable (Monitors Mileage)	53
Section 9 VID Wiring (Monitors Hours)	54
Section 10 VID Wiring with 20-1725 (Monitors Mileage and Hours)	55
Section 11 Component Test	56
Appendix A - Tag Type Matrix	57
Warranty	61

Section 1 Introduction

This manual will give you information about the installation of your Auto Vehicle Identification system components.

1.1 General Safety for Installations.



DANGER: Before any work is done at a fuel island you must carefully read and understand the warnings and cautions in "Hazardous Areas" on page 8.



WARNING: To prevent possible explosion or fire, be careful with open fuel inlets during indoor installations. Make sure there is sufficient airflow and that there are no ignition sources near work areas.



CAUTION: Be sure to use the correct applicable Personal Protective Equipment for all installations.



IMPORTANT: Be sure to carefully read the sub-sections that follow before you do an installation of equipment. They contain important safety and compliance information.

1.2 Security Features



NOTICE: To prevent accidental component removal, tampering or theft, security features have been put in place throughout these procedures. These features are identified with a **Security Features Lock Icon**. It is important to make sure these features are not bypassed.

Refer to M1044-SU AVI Start-up Manual for the order of steps and manual references to install your system.

1.3 Safety Warnings

This manual contains many important Safety Alerts. There can be a risk of injury or damage to property if you do not obey these alerts. The panels below show the types of safety warnings that can be seen and how each is specified.



DANGER: Indicates an immediately hazardous condition that, if not prevented, will result in death or serious injury.



WARNING: Indicates a possibly hazardous condition that, if not prevented, could result in death or serious injury.



CAUTION: Indicates a possibly hazardous situation that, if not prevented, could result in minor or moderate injury.



NOTICE: Indicates important information not related to hazards.

1.4 Hazardous Areas

Any fuel dispenser is a hazardous area as defined in the National Electrical Code. Installation must be in accordance with the following:

- National Electrical Code (NFPA No. 70)
- Motor Fuel Dispensing Facilities and Repair Garages Code (NFPA No. 30A)

1.4.1 NFPA/NEC – Class I, Div. 1 & Div. 2

The Class I, Division 1 and Class I, Division 2 hazardous areas are specified below:

Class I locations. Class I locations are those in which flammable gases or vapors are or may be present in the air in quantities sufficient to produce explosive or ignitable mixtures. Class I locations include the following:

1. **Class I, Division 1.** A Class I, Division 1 location is a location:
 - a. In which ignitable concentrations of flammable gases or vapors may exist under normal operating conditions.
 - b. In which ignitable concentrations of such gases or vapors may exist frequently because of repair or maintenance operations or because of leakage.
 - c. In which breakdown or faulty operation of equipment or processes might release ignitable concentrations of flammable gases or vapors, and might also cause simultaneous failure of electric equipment.
2. **Class I, Division 2.** A Class I, Division 2 location is a location:
 - a. In which volatile flammable liquids or flammable gases are handled, processed, or used, but in which the hazardous liquids, vapors, or gases will normally be confined within closed containers or closed systems from which they can escape only in case of accidental rupture or breakdown of such containers or systems, or in case of abnormal operation of equipment; or
 - b. In which ignitable concentrations of gases or vapors are normally prevented by positive mechanical ventilation, and which might become hazardous through failure or abnormal operations of the ventilating equipment; or
 - c. That is adjacent to a Class I, Division 1 location, and to which ignitable concentrations of gases or vapors might occasionally be communicated unless such communication is prevented by adequate positive-pressure ventilation from a source of clean air, and effective safeguards against ventilation failure are provided.



WARNING: To prevent possible fire or explosion, do not mount your system site controller or any other electrical part of the system, including printers and modems, within or above the defined "hazardous" areas.





IMPORTANT: It is the installer's responsibility to know and obey all local codes.

OPW Fuel Management System's fuel control systems are listed for use in a non-classified area. All of the equipment must be installed outside of the hazardous areas.



NOTE: Local codes can dictate specific installation requirements. Installation is subject to approval by the local authority that has jurisdiction at the site.

1.4.2 Installation Requirement

OPW Terminals are designed to be installed above the hazardous area when using the terminal's associated pedestal.

The pedestal can be mounted in the hazardous area but a seal-off must be the first fitting for all conduits that go into the area.



IMPORTANT: All unused knockout holes that have been removed must be sealed.

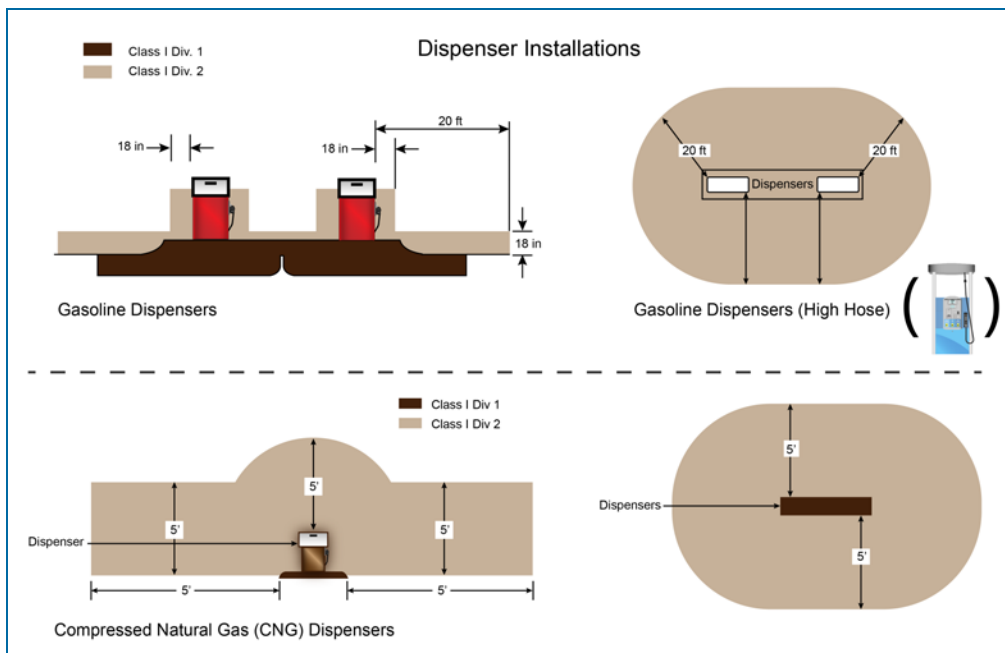

Figure 1-1 Dispenser Installations



WARNING: Knockouts and installation hardware are provided for all cabinetry. Do **NOT** drill holes in the enclosures. This would violate the safety listing of the system.



CAUTION: Be sure to wear all required personal protective equipment (PPE). This includes safety glasses, hardhat, safety shoes and reflective vest.

Barricade the work area before installation.

Be sure to obey all applicable Lockout/Tagout (LOTO) procedures before installation.



IMPORTANT: It is recommended to do a check of the electrical system with a multimeter to make sure all connections are de-energized before you proceed with the installation.

1.5 FCC Compliance

This system complies with Part 15 of the Federal Communications Commission (FCC) Rules & Regulations. Operation is applicable to these conditions:

- This device must not cause harmful interference.
- This device must accept interference received, including interference that can cause undesired operation.

Auto Vehicle Identification Component Installation

The topics in the sections that follow will show the installation procedures for the different components in your Auto Vehicle Identification system. These topics include:

"Radio Frequency Nozzle" on page 13

"Tag Installation" on page 29

"Tag Tuning Procedure" on page 39

"Vehicle Identification Device Installation" on page 44

"AVI Wire Harness with GPS Odometer Sender (GOS)" on page 48

"Auto Vehicle Identification System Power" on page 50

"VID Wiring with 20-1725 GOS Cable (Monitors Mileage)" on page 53

Section 2 Radio Frequency Nozzle

The Radio Frequency Nozzle (RFN) is a RF transmitter/receiver that can collect and transmit information between different system devices. An RF unit installed on a nozzle can:

- Communicate with a Fuel Site Controller (FSC).
- Communicate with tags.
- Communicate with a Vehicle Identification Device (VID).

2.1 Battery Assembly



WARNING: DO NOT install or change batteries while in a hazardous area! This could cause fire or explosion that could lead to personal injury or death. See "[Hazardous Areas](#)" on [page 8](#) for more information.

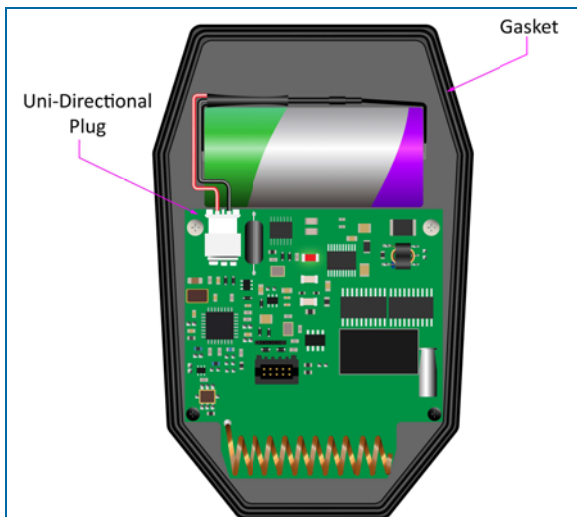

The RFN unit is supplied with the battery connector disconnected. To connect the battery:

- Remove the four cover screws.
- Remove the RFN cover.
- Put the battery in the battery compartment with the connector cable on the left.
- Connect the male battery connector to the female RFN connector on the board (see NOTE below).



NOTICE: The routing of the battery cable must be around the top of the battery as shown in the illustration above. **Wires caught between the battery and the inside of the cover can be easily damaged.**



CAUTION: A pinched battery cable can overheat and cause burns.



- Make sure the cover gasket is correctly installed in the gasket groove.
- Test the RFN with the Auto Vehicle Identification TAG Writer.
- Replace the cover and screws.

The RFN PCB has an indication LED that will flash when the battery is connected. This shows that the unit is in correct RFN operation.



NOTE: The male and the female terminals of the battery connectors are interlocked and uses a uni-directional plug to prevent incorrect connection. If the connectors cannot be engaged, turn the connector in the opposite direction and try to engage again. To disconnect the battery, make sure to push the lever on the battery connector before you pull the connectors apart.

2.1.1 Replacement Battery Kit (OPW-FMS P/N 48-0216)



DANGER: The lithium battery in this device can explode, cause fire or cause a chemical burn if it is used incorrectly. Do not recharge, disassemble or discard this battery in fire. Replace this battery with an OPW/ZVA Battery Kit (FMS part number 48-0216) ONLY. Obey the precautions in this section to prevent a dangerous condition.



WARNING: You must refer to local and state regulations for the correct method of battery recycling and disposal. Do not incinerate discharged batteries. Do not put batteries in the trash (unless local regulations permit discharged lithium batteries in the trash).



A battery replacement kit is available (RFN OPW/ZVA Battery Kit). When it becomes necessary to change the battery, use the steps below:

- Remove the four cover screws.
- Remove the RFN cover.
- Unplug the battery cable.
- Remove the old battery from the battery compartment.
- Remove the old gasket and replace it with the gasket provided in the kit.
- Put the battery in the battery compartment with the connector cable on the left.
- Connect the male battery connector to the female RFN connector on the board.
- Replace the cover and screws.

2.2 RFN Installation on OPW/ZVA Nozzles

The RFN can be used with three (3) different nozzle adapters that can be installed on OPW7H, OPW11A and VZA25 nozzles. You will need a 2 mm Allen wrench to install the adapters and RF Unit on the nozzle.

2.2.1 Installation on OPW7H / VZA25 Nozzles

The installation of the OPW7A and VZA25 adapters with an OPW/ZVA RF Unit is the same.



1. The RF unit has three (3) Screw Alignment Guides and the adapter has three (3) Screw Alignment Slots.
2. Align the slots in the front of the adapter with the guides in the rear of the RF Unit.
3. Push the adapter through the opening in the RF unit until it is flush.
4. Install the RF with adapter onto the nozzle as far to the end as it will go. Tighten the three (3) Allen screws to compress the adapter so it is tight around the nozzle and cannot be pulled off.
5. Attach the rear of the RF unit to the nozzle:
 - a. Put a gas and oil/UV resistant cable tie of an applicable length around the nozzle and through the slots in the rear of the RF unit as shown in the image above.]
 - b. Pull the tape of the cable tie through its ratchet until it is tight and cut off the unwanted tail with a wire cutter.

2.2.2 Installation on OPW11A Nozzles

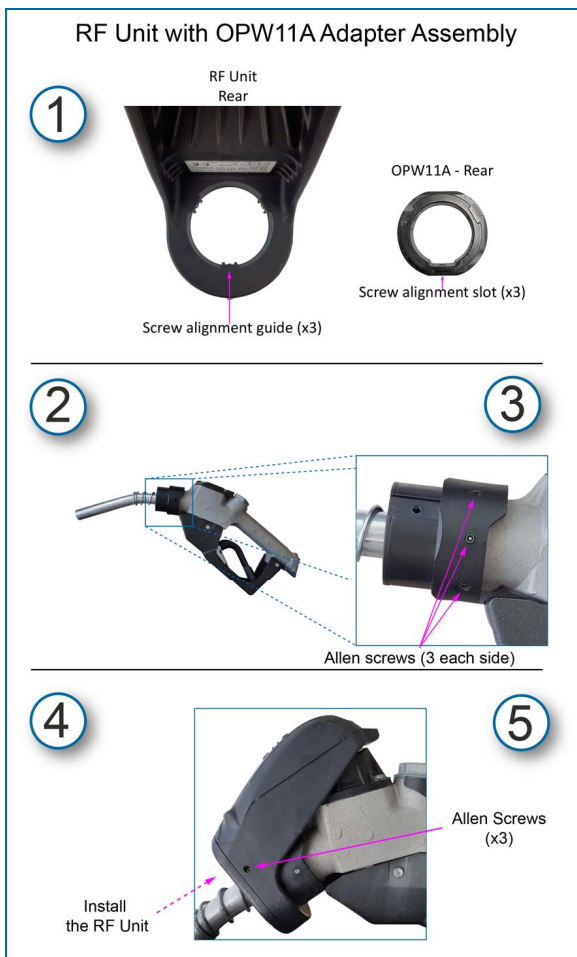

1. The RF unit has three (3) Screw Alignment Guides and the adapter has three (3) Screw Alignment Slots.

2. Put the Adapter onto the nozzle and push it into position on the nozzle housing as shown in the illustration. Make sure the alignment guides in the adapter are in the correct position.
3. Tighten the Allen screws to hold the adapter in position. There are six (6) Allen screws total (three [3] Allen screws on the two sides of the adapter).
4. Install the RF Unit onto the adapter so that the guides of the RF Unit and slots of the adapter are aligned correctly. Push the RF Unit onto the adapter as far as it will go
5. Tighten the three (3) Allen screws to attach the RF Unit to the adapter.

2.3 Split-Design RFN (SRFN) – Installation on OPW11A and OPW7H Nozzles

In a Split-Design RFN (SRFN), the Reader Unit is installed at the rear of the nozzle. This is to make operation easier with low-load body vehicles and vehicles with small recessed fuel inlets. The Antenna and Reader Unit are isolated. Connectivity between the two assemblies is through a Coaxial Cable in a protective stainless steel pipe.

The image below shows how a nozzle looks before and after the SRFN is installed.

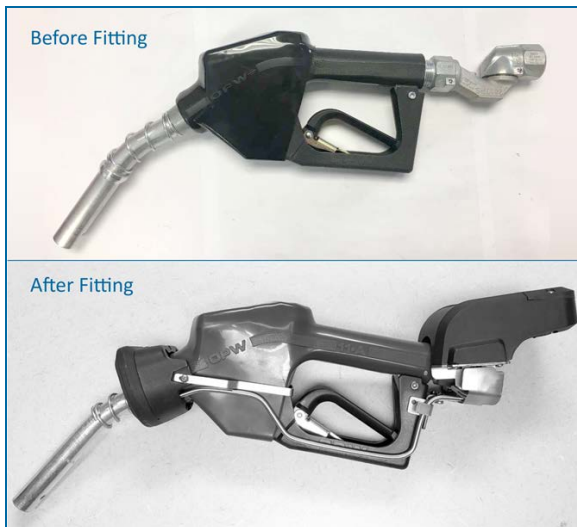

2.3.1 SRFN Components

Make sure that your SRFN kit (75-3062 standard version, 75-3063 push-button version) contains all of the necessary components before you do the assembly.

SRFN Components	
Name	QTY
Fastener Plate	1
Reader Bracket	1
SRFN Antenna	1
Antenna Bracket	1
Coaxial Cable	1
SRFN Reader	1
Cable Protector	1
4.5mm Stainless Steel Mini Tie-Lok	1

SRFN Components	
M4 x 10mm Screw	1
M4 Star Washer	3
6-32 x 8mm Screw	2
6-32 x 12mm Screw	2
M4 Spring Washer	4
M4 8mm Screw	2
6-32 x 5/8" Screw	2



SRFN Kit

2.3.2 SRFN Assembly



IMPORTANT: The SRFN Antenna and Reader can be shipped with protective rubber boots installed. It is not necessary to remove these protective rubber boots to install these components. You will be instructed to remove the screws that are installed with the boots in the assembly steps. Make sure to keep these screws in a safe location so they can be re-installed. These screws are slightly longer because of the thickness of the rubber.



1. Put the Fastener Plate into the rear of the nozzle handle guard. Hold it in the position as shown above.

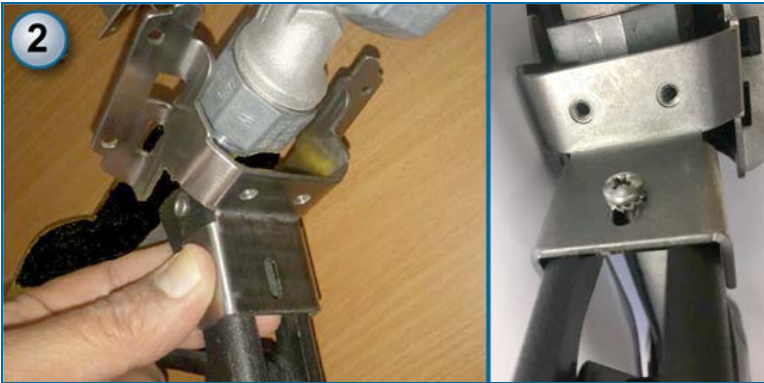

2. Put the Reader Bracket on the front of the nozzle handle guard. Hold the Fastener Plate and Reader Bracket in position as shown in the photo on the left above. Put a M4 x 10mm Screw with a M4 Star Washer through the slot of the Reader Bracket and into the threaded hole in the Fastener Plate. Tighten the screw (torque approximately 22 in-lb).

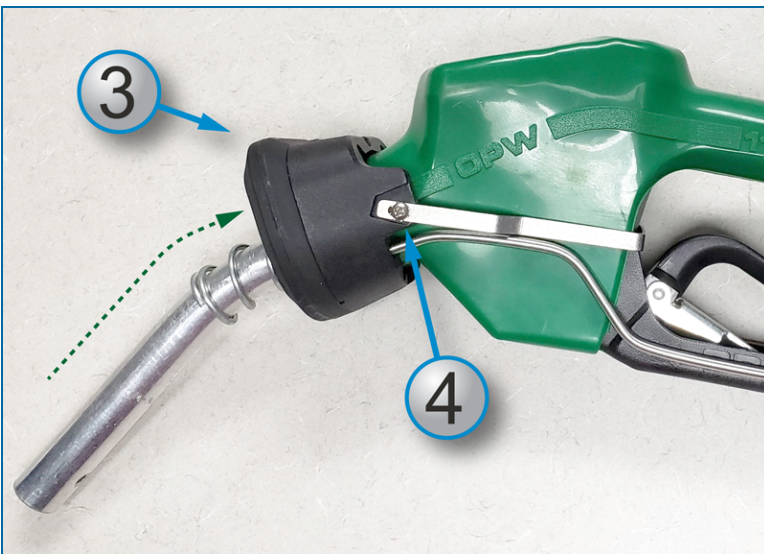

3. Put the nozzle through the Antenna assembly so that it is flush as shown above with the antenna tube on the left side of the nozzle.



NOTE: It is not necessary to remove the OPW OEM rubber nozzle cover if one is installed.

4. Attach the antenna bracket with two (2) 6-32 x 8mm Screws and two (2) M4 Star Washers (torque approximately 17 in-lb).



IMPORTANT: For Antenna Assemblies shipped with a protective rubber boot installed You must first remove the screws that hold the boot to the antenna. Pull back the rubber sufficiently to get access to the bracket slots. Put the Antenna Bracket into the slots so that the



bracket is installed at the correct angle. Put the screws back through the metal grommet in the boot, through the slotted hole in the bracket and into the threaded screw receiver. Tighten the screws.

5

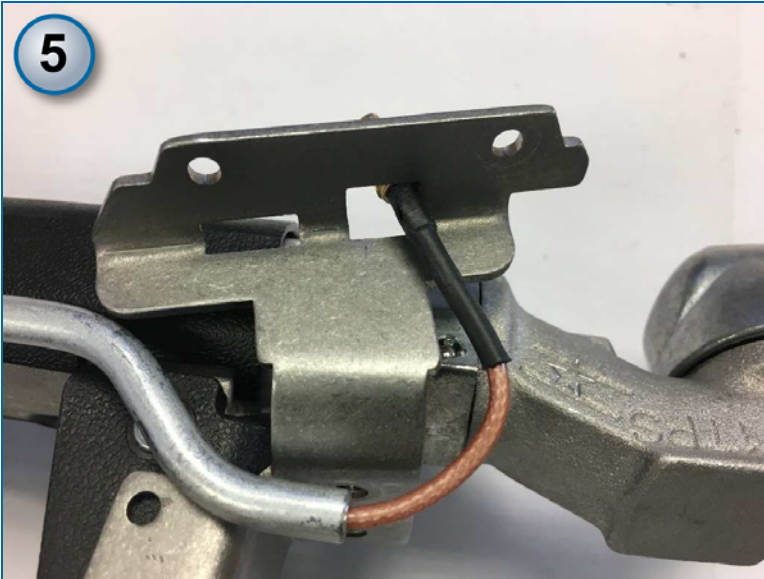

5. Put the connector end of the Coaxial Cable through the square hole in the Reader Bracket.

6a



IMPORTANT: For Reader Units shipped with a protective rubber boot installed
Loosen the two (2) Boot Screws completely. The screws will stay in place in the rubber screw



6. Hold the Reader Unit in the position shown in the photo above. Put the Coaxial Cable connector into the SMA plug on the bottom of the Reader. Push it into the plug so that it clicks.



7. Fasten the Reader Unit to the bracket. Put two (2) 6-32 x 12mm screws with M4 Spring Washers through the rear holes of the Reader Bracket and into the screw receivers (torque to approximately 17 in-lb).

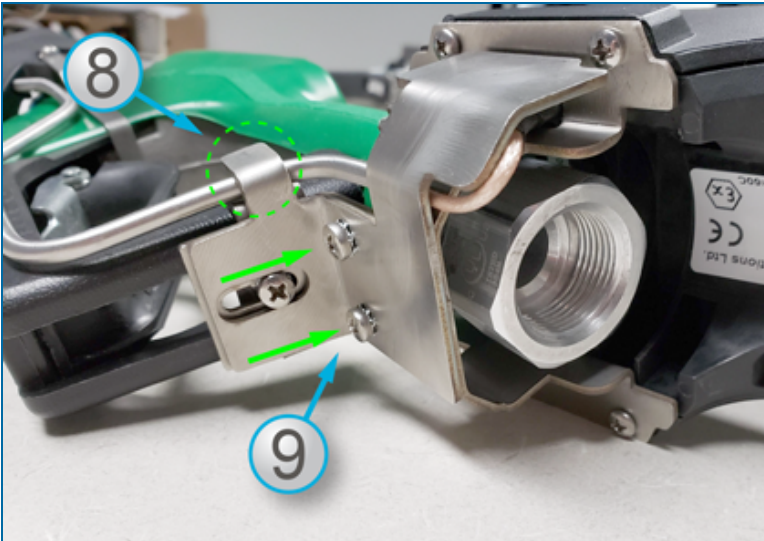

8. Attach the Cable Protector to the Reader Bracket so that it covers the open section of the Coaxial Cable that was connected in step 6 above. The protective metal tube of the Antenna cable must be put into the clip part of the bracket.
9. Put two (2) M4 x 8mm Screws with M4 Spring Washers through the holes in the bottom of the Cable Protector and into the screw receivers in the Reader Bracket (torque to approximately 17 in-lb).
10. Battery Connection:



WARNING: DO NOT install or change batteries while in a hazardous area! This could cause fire or explosion that could lead to personal injury or death. See "[Hazardous Areas](#)" on [page 8](#) for more information.





a. Remove the battery cover screws and open the battery compartment.

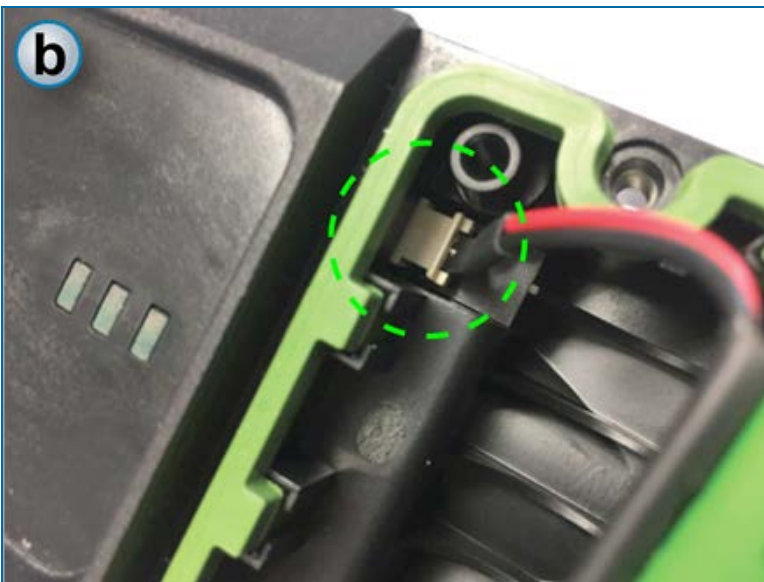

b. Remove the battery and connect the battery connector into the receptacle as shown above.



c. Put the battery back inside its compartment as shown above.



NOTICE: The routing of the battery cable must be around the top of the battery as shown in the illustration above. **Wires caught between the battery and the inside of the cover can be easily damaged.**



CAUTION: A pinched battery cable can overheat and cause burns.



- d. Do a check to make sure the red LED flashes quickly. This indicates that the internal super capacitor is in a charging state.
- e. Make sure the cover gasket is correctly installed in the gasket groove.
- f. Replace the battery cover and tighten the screws (torque to approximately 8 in-lb).



IMPORTANT: For Reader Units shipped with a protective rubber boot installed
Replace the SFRN Reader Cover rubber boot. Tighten the two (2) 6-32 x 5/8 (16mm) screws (torque to approximately 4.43 in-lb).

2.4 Boot Installation

An optional rubber boot can be installed to protect the RFN from the effects of weather and moisture.



Boot with LED Cutout

2.4.1 Boot Installation with Pre-Installed RFN

If the RFN has been installed on the nozzle the boot can be pulled over the nozzle and stretched over the installed RFN.



Put the nozzle through the boot.



Stretch the rear of the boot over the rear of the handle so that it fits tightly.

Section 3 Tag Installation



WARNING: To prevent possible explosion or fire **DO NOT USE CORDED ELECTRIC OR BATTERY OPERATED POWER TOOLS NEAR FUEL INLETS!** Only use pneumatic or manual tools.



Tags are used to communicate with the pump RF Nozzle (RFN). In most commercial vehicles, tags are attached around the top of a "longneck" fuel inlet. In light motor vehicles, tags are installed around the fuel inlet. Refer to "[Tag Type Matrix](#)" on page 57 for more information about available tags.



NOTE: Metallic surfaces can decrease the range that an RFN can read a tag. The Tag's internal diameter should be minimum of 1 cm more than the external diameter of the fuel inlet.

The maximum range that can be read between the RFN and Tag attached to a fuel inlet is 4 - 6 inches (10 - 15 cm). Use the correct tag that will keep this distance or less between components.

Use the installation procedures below to make sure Tags cannot be easily removed.



IMPORTANT: It is recommended to keep the tag's serial sticker inside the gas door or the vehicle door jamb for reference.

3.1 Flush Mount Fuel Inlets

(for Autos, Light Duty and Commercial Vehicles)

Plastic P-Clips can be used to attach the Tag to the vehicle body around the fuel inlet. Recommended tag types include:

- Flexible
- Flexible with tail
- Rigid with Tail
- Button Tags
- Moon Tags



Figure 3-1 Tag with P-Clips Installed

P-Clips can be used to attach the tag to the fuel inlet. P-Clips can be permanently installed with the use of one-way screws, pop rivets or self-tapping screws (screw heads must be filled with a fuel-resistant epoxy so the screw cannot be removed). 🔒



NOTE: For maximum security, seal the screw with a fuel resistant epoxy.



NOTE: If this level of security is not important, an equivalent regular screw can be used as an alternative.

The tails of Tags with security tails must be installed with one-way screws only. 🔒



Figure 3-2 Mini-flex Tag

Mini-flex Tags are installed the same as the flexible tags. A 2.5 mm (0.10 in.) guide hole must be drilled into the vehicle's body for the supplied one-way screw. If this screw is removed, the tag will be damaged and unserviceable. 🔒



Figure 3-3 Moon Tag

Moon Tags must be installed with the supplied one-way self-tapping screw. 🔒 Tape is also supplied to put on the bottom of the tag for a stronger bond.



NOTE: Use moon tags only when no other tag type is possible.

3.2 Capless Fuel Inlets

Since 2009 several US auto manufacturers have begun to install Capless Fuel Inlets in many autos and other Light Duty Vehicles as a convenience and anti-fuel theft feature.

A 70-80 mm Mini-flex Tag is recommended for installations on a vehicle equipped with a Capless Fuel Inlet. It is not necessary to use P-Clips in this type of installation. A 2.5 mm (0.10 in.) guide hole must be drilled into the vehicle's body for the supplied one-way screw. If this screw is removed, the tag will be damaged and unserviceable. 🔒



Figure 3-4 Mini-flex Tag Installed on a Capless Fuel Inlet

3.3 Buses and Trucks

3.3.1 Short Neck Fuel Inlets

Tags cannot be installed with P-Clips on short neck fuel inlets. The different Tag types below can be used on these inlets.



Figure 3-5 Collar Tag

A Collar Tag is isolated and can give a good reading range with the same signal strength around the tag.



Figure 3-6 Collar Tag Installed on Inlet



Figure 3-7 Collar Tag with Tail

3.3.2 Fuel Inlet Tag with Holder



Figure 3-8 Tag with Holder

A Fuel Inlet Tag with Holder is applicable to vehicles with a short fuel inlet where a strong installation is necessary near a working area.

3.3.3 Truck Tag



Figure 3-9 Truck Tag

A Truck Tag is applicable to vehicles with a short fuel inlet connected close to the edge of a tank. This type of tag is installed with a 10 mm stainless steel band. Use a fuel-resistant epoxy on the bottom of the tag to hold it in place. The RF field of this tag type is localized and the RFN must be held close to the tag to operate correctly.



NOTE: A banding tool is necessary to install this type of Tag.

3.3.4 Long Neck Fuel Inlets

Flexible Tags are applicable to vehicles with Long Neck Fuel Inlets where Tag Holders are used to install the tag on the fuel neck. The Tag Holders are installed on a Stainless Steel Strap that is tightened around the fuel inlet. Tag Holders come in packages of five (5). Tag installations can use four (4) holders if the fuel inlet is less than 110 mm (4.33 inches). For larger fuel inlets it can be necessary to use five (5) to six (6) holders.

Select a Tag (Flexible or Rigid) with an inner diameter that is 10 – 15 mm (0.40 - 0.60 inches) larger than the outer diameter of the fuel inlet.

Use a safe cleaner ((such as ZEP Citrus Degreaser, Simple Green or Safe-N-Clean) and a clean cloth to degrease area around the top of the fuel inlet where the Tag is to be installed.



To install a Flexible Tag with Tag Holders:

1. Open each of the P-clips that will be installed.
2. Install each of the P-clips as shown in the illustration so the rear of the clips point toward the inside of the tag circle.
3. Snap the rear of each of the Holders into the front of each of the P-clips as shown in the illustration.
4. Completely loosen the screw on the Stainless Steel Band to release the end. Put the Steel Band through each of the holders. Engage the end of the Steel Band into its screw housing.
5. Move the assembled tag with holders into position on the tank inlet. Make sure that the fuel cap does not snag on the Tag. Turn the screw clockwise until the clamp is tight and cannot move.



NOTE: Make sure that the holders are spaced evenly around the tag before you tighten the Steel Band.

6. Tighten the Set Screws on the Holders with a 2 mm Allen Key to prevent the mechanical removal of the Tag and Holder assembly.
7. Break off the small cylindrical piece from the corner of each holder. This is the Set Screw Plug.
8. Push the Set Screw Plug into the Set Screw Cavity in the Holder so that it fits tightly. 🔒
9. For Tags with tails: Drill a 2.5 mm (0.10 in.) guide hole into the vehicle body where the Tag tail is to be installed. Use the supplied one-way screw to attach the Tag tail to the vehicle body. 🔒



TIP: A fuel-resistant epoxy can be applied to the bottom of the tag tail for a stronger bond.

3.3.5 Long Neck Fuel Inlets Less than 45 mm (1.77 in.)

On Long Neck Fuel Inlets that are less than 45 mm (1.77 in.), installation with Tag Holders is not possible. The procedure below shows an alternative installation.



1. Components:
 - Steel Band of the correct diameter for the fuel inlet where it will be installed (50-0491 - 50-0495).
 - P-Clips (minimum of five [5]) (50-0503). See step 2.
 - Use the same quantity of cable ties (50-0504).
 - Tag of the correct diameter (measure the outer diameter of the fuel inlet and add 10 mm).
2. Cut off the bottom part of the P-Clips as shown above. Only the circular part will be used.

3. Install the circular parts of the P-Clips onto the tag so that the round side is up and the open end faces out. Make sure they are spaced evenly.
4. Place the Steel Band around the fuel inlet. Tighten it enough so that there is space to install the cable ties between the band and the inlet.
5. Push each of the cable ties up between the Steel Band and the inlet so that the ends point up. The cables' teeth and flat part of the ratchet end should face out.
6. Install the Tag over the Steel Band.



IMPORTANT: Before you tighten the cable ties, make sure that the Steel Band is in the highest position on the inlet. Be sure that the Tag cannot get caught when the cap is closed.

7. Tighten the cable ties around the Tag at the location of the plastic P-Clips.



NOTE: The P-Clips provide RF isolation for the Tag. The Tag should not come in contact with the Steel Band.

8. Tighten the Steel Band and cut off the remaining Steel Band tail.
9. Cover the Steel Band screw with Pratley Steel to prevent the removal of the screw. 🔒
10. Cover the ratchet part of the Cable Tie with Sikaflex (or equivalent) so the Cable Tie does not come loose. 🔒
11. The installation is complete.



REMINDER: After the tag has been tuned, seal the tuning cavity with a fuel resistant adhesive.

Section 4 Tag Tuning Procedure

This guide will help you to tune a Tag to its highest reading range with an RFN Test Unit. The listed items below will be necessary:

- RFN Test Unit (OPW-FMS P/N 75-3066)
- 2.6 mm Slotted Ceramic Screwdriver (OPW-FMS P/N 56-0034)



NOTICE: To prevent interference between the Tag and the RFN do not use a metal screwdriver.

- Tag
- Dispenser Nozzle
- Cable Tie



Use a cable tie to attach the RFN Test Unit onto the nozzle that is used to dispense fuel at the site. Make sure the battery is plugged in. You must wait 1-2 minutes for the RFN to boot up.

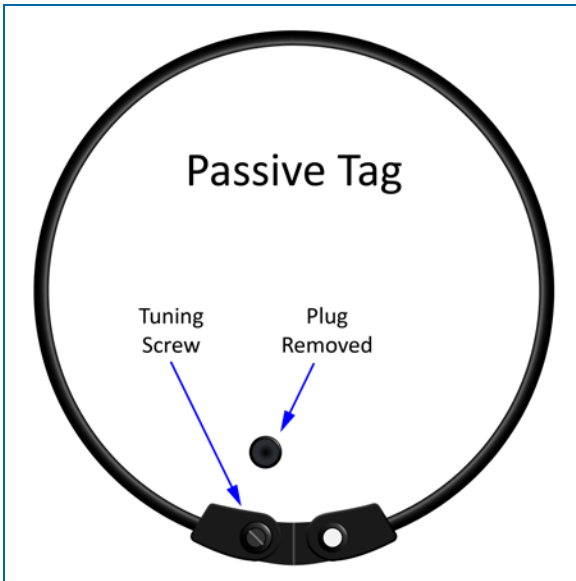

Remove the plug on the Tag to gain access to the tuning screw inside the hole.

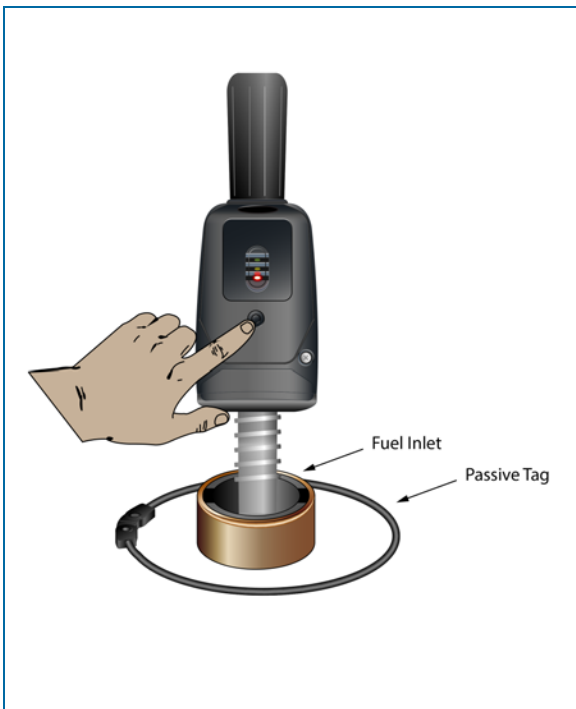

Put the nozzle with the RFN Test Unit into the fuel inlet and push the start button.



Put a CERAMIC screwdriver into the tuning hole. DO NOT USE A METAL SCREWDRIVER.



Turn the tuning screw clockwise until the green LED light on the RFN Test Unit flashes and you hear the beeper. This indicates that the tag is in reading range.

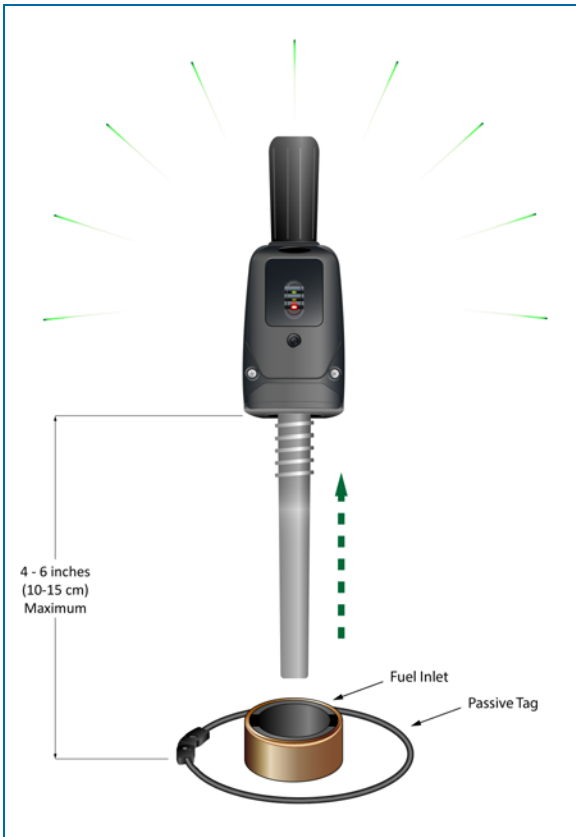

Move the RFN Test Unit away from the tag until the green LED light and beeper stop. Turn the tuning screw clockwise until the LED starts to flash and you hear the beeper again. Do this until you can no longer increase the reading range.

When the reading range can no longer be increased, you are at the maximum reading range of the tag. This should be 4-6 inches (10-15 cm) between the tag and the RFN Test Unit.

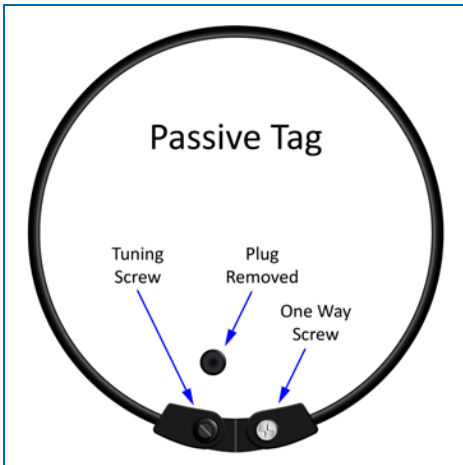

Use the RFN Test Unit again to make sure that the tag is in reading range (RFN Test Unit light will flash). Then use the RFN Test Unit to tune the tag to its *optimal* reading range. The optimal reading range is when tag can only be read when the nozzle is fully engaged in the fuel tank inlet.



IMPORTANT: The tag must **ONLY** be in reading range when the nozzle is fully engaged in the fuel tank. This is the tag's **OPTIMAL** range. Make sure that the tag cannot be read when the nozzle is not fully engaged.

When the tag is at its optimal reading range, try a transaction at the pump.



If a correct transaction is made, the tuning hole plug must be replaced and sealed with a fuel-resistant epoxy.



IMPORTANT: The tuning hole plug must be sealed so the optimal reading range can not be changed after it is set. 🗝️ The seal also protects the tuning port from weather and moisture damage.

Section 5 Vehicle Identification Device Installation

Necessary Tools



CAUTION: Wear safety glasses and obey all safety warning panels in this manual.



VID Installation Tools

To see the OPW University instructional video "AVI VID Installation scan the code below or visit, <https://www.youtube.com/watch?v=msYRh1xf3Dc>



5.0.0.1 Installation Conditions

A Vehicle Identification Device (VID) can be installed in a vehicle to communicate specified data (OBD diagnostic, Odometer, Hour Meter etc.) to the Vehicle Identification System (VIS). This data is communicated between the VID and VIS through a long-range antenna. A VID can identify a nozzle at a refuel point by either a wired inlet antenna, or through a matched Tag's serial number. This serial number must be programmed in the VID internal memory.

- Install the VID where it cannot be seen and where it has protection from weather and mechanical interference.
- When a VID is to be installed in a private vehicle it is recommended to install it behind a partition (such as a wall inside the trunk or behind the kick panel).
- A VID must be installed so that the LEDs point out and can be easily seen.
- Attach the VID to a wall of the vehicle with screws or cable ties.* Make sure it is installed tightly to prevent vibration that could result in audible noise or cause its wires to break off.
- Do not install the VID in an area where regular vehical maintenance can occur.

* Two (2) M6 nuts and bolts, or two (2) 11 inch cable ties (UV and fuel resistant).

The Auto Vehicle Identification VID comes with a built-in hour meter. The hour meters are pre-calibrated with the number of pulses per hour (PPH - 14,400). This number must be programmed into the tag when the hour meter is calibrated.

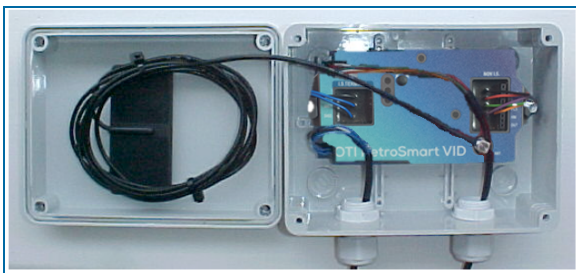

When the VID is installed in an extreme weather or temperature environment the Tag and VID must be contained in a Tag Enclosure ([Gewiss GW 44 206](#)) (see image above).

5.1 VID Wiring

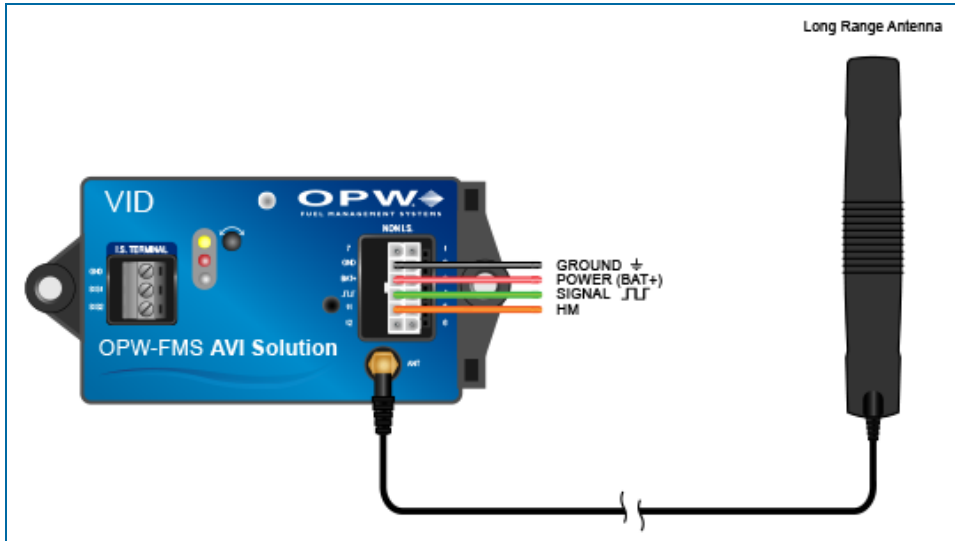

VID Wiring

- Black: Connects to vehicle ground. Do not connect directly to the vehicle body.
- Red: Connects to vehicle's constant DC power supply via an inline fuse, maximum supply voltage 30V. Tag current supply typically 15mA.
- Green: Connects to the GOS unit output to record the distance traveled.
- Orange: Connects to the D+ terminal of the alternator for the hour meter.

5.2 Long Range Antenna Installation

Use the SMA connector end of the Antenna wire to connect the Antenna to the VID (see the illustration above).



Use the supplied double-sided adhesive to install the Antenna on the windshield. The Antenna should be installed at the bottom corner of the windshield approximately 1 inch from the windshield edge (see the photo above).



IMPORTANT: The Antenna must be installed a minimum of 3 cm (1.18 in.) from the nearest metallic surface. Do not make kinks in the Antenna cable.

Section 6 AVI Wire Harness with GPS Odometer Sender (GOS)

OPW-FMS Part Number 20-1725

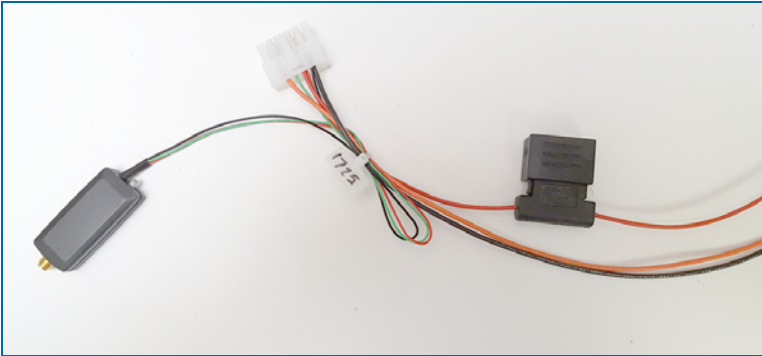

The GOS Control Module is used to monitor the road distance traveled without an interface to sensitive vehicle electronic systems.

There are two (2) types of GOS antenna available for specified vehicles:

- Adhesive Installed Antenna: For sedans, light duty vehicles and motorcycles.
- Roof Installed Antenna: For trucks and Buses.

6.1 GOS Antenna Installation

The position of the GOS antenna installation is very important for the operation of the GOS Control Module. The antenna plane must be installed horizontally, parallel to the geographic horizon. The antenna must have full view of the sky to make sure the antenna has a direct line-of-sight with as many satellites as possible. There must be no metallic obstruction between the GOS antenna and the satellite constellation.

6.1.1 Adhesive Installed Antenna

If the vehicle has a sloped windshield (front or rear) the Adhesive Installed GOS antenna can be installed under that windshield's sill compartment. The antenna should be installed as close to the edge of the windshield as possible. The antenna **MUST** be installed under a plastic housing, not metal.

- Clean the surface where the antenna will be installed with a safe cleaner (such as ZEP Citrus Degreaser, Simple Green or Safe-N-Clean).
- When the surface is dry, use the supplied double-sided tape to bond the antenna to the surface.

6.1.2 Roof Installed Antenna

If the vehicle's windshield is perpendicular to the sill compartment, a Roof Installed Antenna must be used.

- Drill a 13 mm hole in the cab roof.
- Clean the surface where the antenna will be installed with a safe cleaner (such as ZEP Citrus Degreaser, Simple Green or Safe-N-Clean).
- Remove the protection tape from the bottom of the antenna.
- Remove the bulkhead connector nut and washer.
- Apply a small bead of weatherproof silicone around the bottom of the antenna.
- Put the cable and bulkhead connector of the antenna assembly through the 13 mm hole.
- Put pressure on the top of the antenna to make sure the adhesive and the weatherproof silicone make a good seal.
- From the inside of the cab Put the washer and nut of the antenna assembly on the threaded bulkhead connector. Turn the nut clockwise until it is tight.
- Wind the cable into a coil until it is time to install the cable. Do not let the cable get kinked.

6.2 GOS Control Module Installation

The GOS Control Module can be mounted under the dash or kick-panel. It is important that the GOS Control Module be installed in an area that is protected from the elements.

The GOS Control Module must be attached to a body panel with 2 x CB3 Cable Ties to prevent movement when the vehicle is in motion.

See "[VID Wiring with 20-1725 GOS Cable \(Monitors Mileage\)](#)" on page 53 for 20-1725 wiring connections.

Section 7 Auto Vehicle Identification System Power

The Auto Vehicle Identification system must always get access to an uninterrupted power source (+) from the vehicle when a VID is installed. This is usually from the fuse compartment or, in unusual conditions, from the battery.

Use a volt meter to do a test to see if the constant power line has power all the time even if the ignition is in the off position.

7.1 Fuse Holder

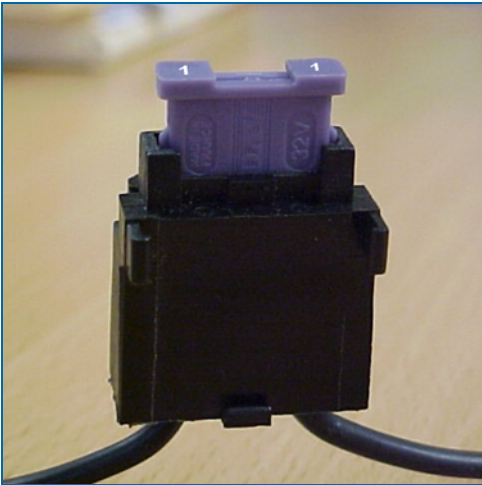

Fuse Holder (with 1 Amp Fuse)



WARNING: Remove the 1 Amp fuse from the VID Fuse Holder before you do this procedure to avoid possible electrical shock.



To connect the VID to the vehicle's power source:

- Remove the fuse holder cap.
- Temporarily remove the 1 Amp fuse from the VID's fuse holder.
- Remove a small part of the insulation of the vehicle's constant power wire.
- Solder the fuse holder wire to the wire of the constant power source where the insulation was removed.
- Connect the ground wire to an applicable ground location. It is recommended to wire the ground to the negative (-) battery terminal.
- Wrap all electrical connections completely with electrical insulation tape.



NOTE: Some vehicles have a "cut-off" switch that can be used to disconnect the battery from inside the vehicle. The power supply to the tag must bypass this switch for the VID to have uninterrupted power.

7.2 Power Supply Connections

7.2.1 Light-Duty Vehicles

» The VID power supply must get its power from the fuse compartment. Connect the fuse holder to the battery side of an unused fuse. If an unused fuse is not available, connect the fuse holder to the battery side of a constant power source circuit. All cable joints must be soldered and insulated with a good quality insulation tape.



NOTE: In some vehicles (e.g., BMW) power to the VID can only come directly from the battery.

» The VID fuse holder must be installed near the fuse compartment. Find a location where you can get easy access if repairs are necessary.

TIP: If the VID cannot be installed in a location close to the fuse holder, a 0.75mm², 4-core Cabtyre cable must be used as an extension.



- » Connect the brown wire of the extension to the tail of the the fuse holder.
- » Connect the blue wire of the extension to the vehicle's black or green ground wire. **DO NOT CONNECT TO THE CHASSIS!**
- » Connect he Yellow/Green wire of the extension cable to the pulse output of the GOS Module.
- » Connect the black wire of the extension to the D+ of the alternator or the ignition switch.

» Use cable ties to install the fuse holder to the vehicle body. Do not let the fuse holder hang loose.



NOTE: If the VID is installed in a car trunk, it is recommended that the power and pulsar cables be routed through the inside of the car.

» Replace the fuse holder cap.

» Put the 1 Amp fuse back in the fuse holder. The red LED should come on.

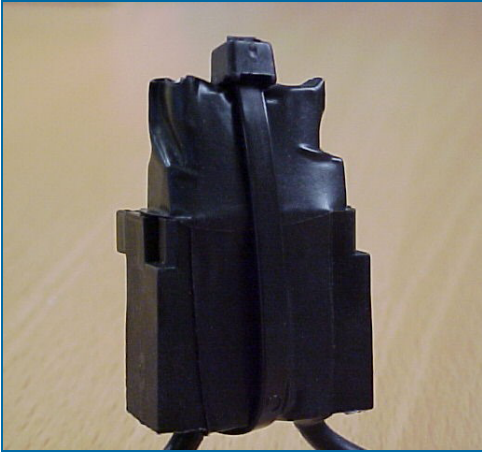

Fuse Holder Wrapped with Tape and Cable Tie

» Wrap the assembled fuse holder tightly with electrical insulation tape. Put a cable tie around the wrapped fuse and fuse holder and pull it tight. Cut off the unwanted length of cable tie with a wire cutter.

See the photo above. This will prevent accidental removal of the fuse from the holder. 🔒

7.2.2 Trucks and Heavy-Duty Vehicles

The installation of the fuse holder in trucks and heavy-duty vehicles is much the same as for cars and light-duty vehicles. There can be differences applicable for some vehicles as shown below.

The power for the VID must come from the fuse compartment (as shown in "[Light-Duty Vehicles](#)" on the [previous page](#)).



NOTICE: Power to the VID must never come from an On Board Computer (OBC), Cell Phone Kit, Tracking System, Tachometer or any other internal source. In a co-driver system, do not splice into the co-driver's wiring loom.



NOTE: In tractors and forklifts, power to the VID can only come directly from one of the batteries of a 24V battery combination or from a single battery where a 12 Volt supply would occur.

For installations where the VID power supply cable must be connected to the battery terminals, the fuse holder must be installed in the cab (protected from rain and moisture), near the VID.

You must be able to get access to the fuse holder without the removal of the vehicle's dashboard.

Use cable ties to install the power cable and be sure it is not near moving or heated parts of the engine (this is very important when installed in tractors and forklifts).

Do not install the fuse holder where it can get wet.

Section 8 VID Wiring with 20-1725 GOS Cable (Monitors Mileage)

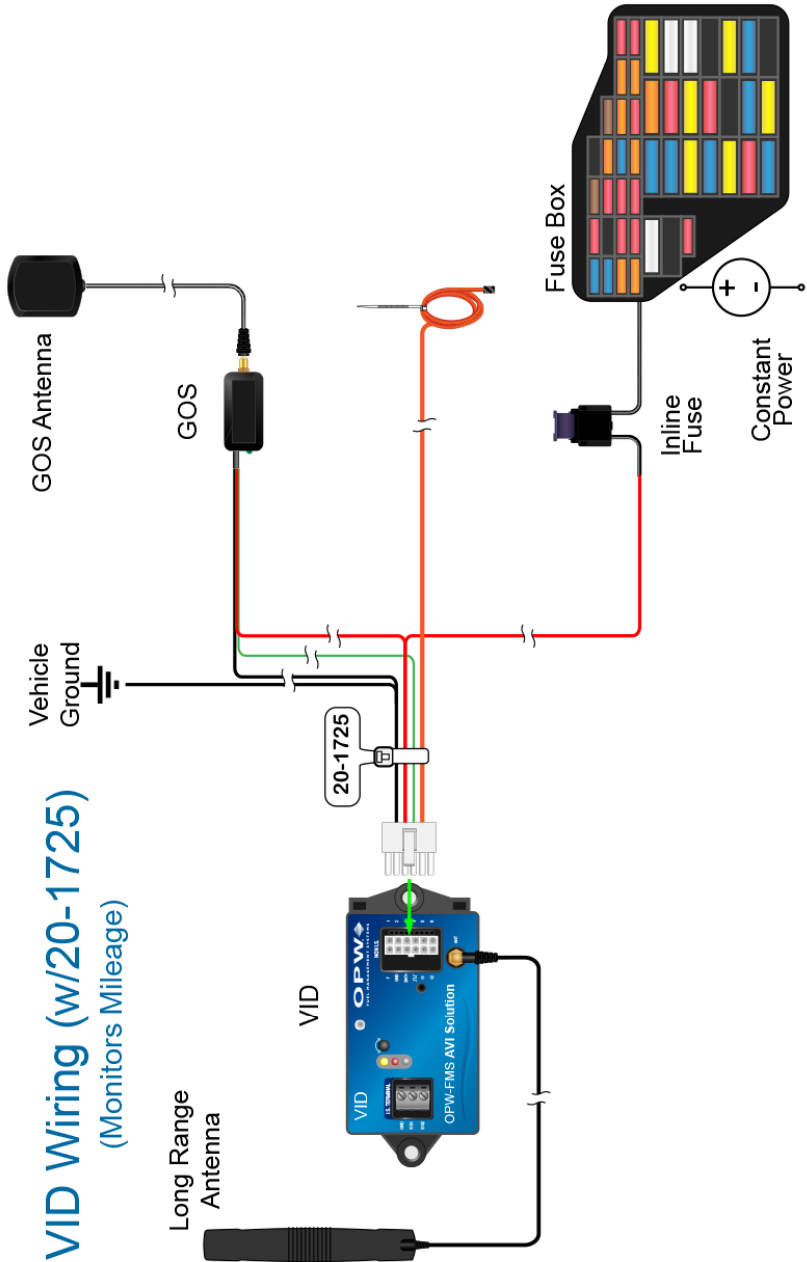

Section 9 VID Wiring (Monitors Hours)

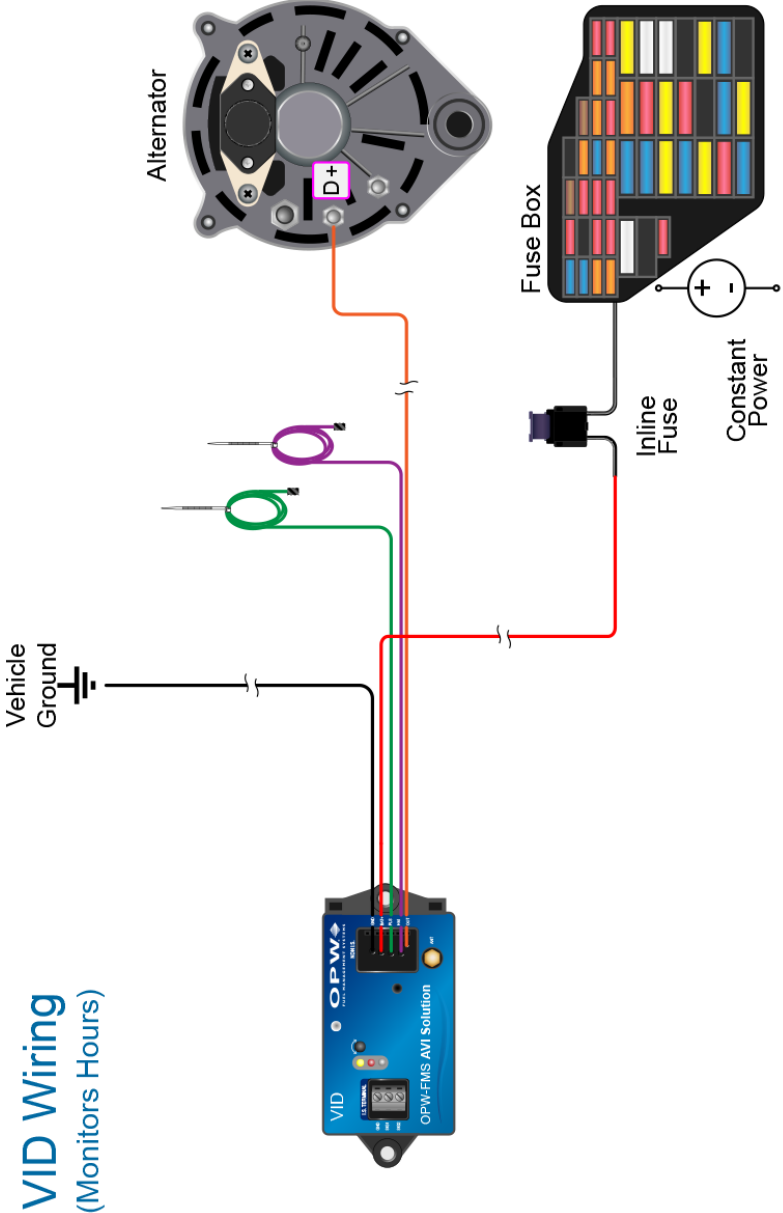

VID Wiring
(Monitors Hours)

Section 10 VID Wiring with 20-1725 (Monitors Mileage and Hours)

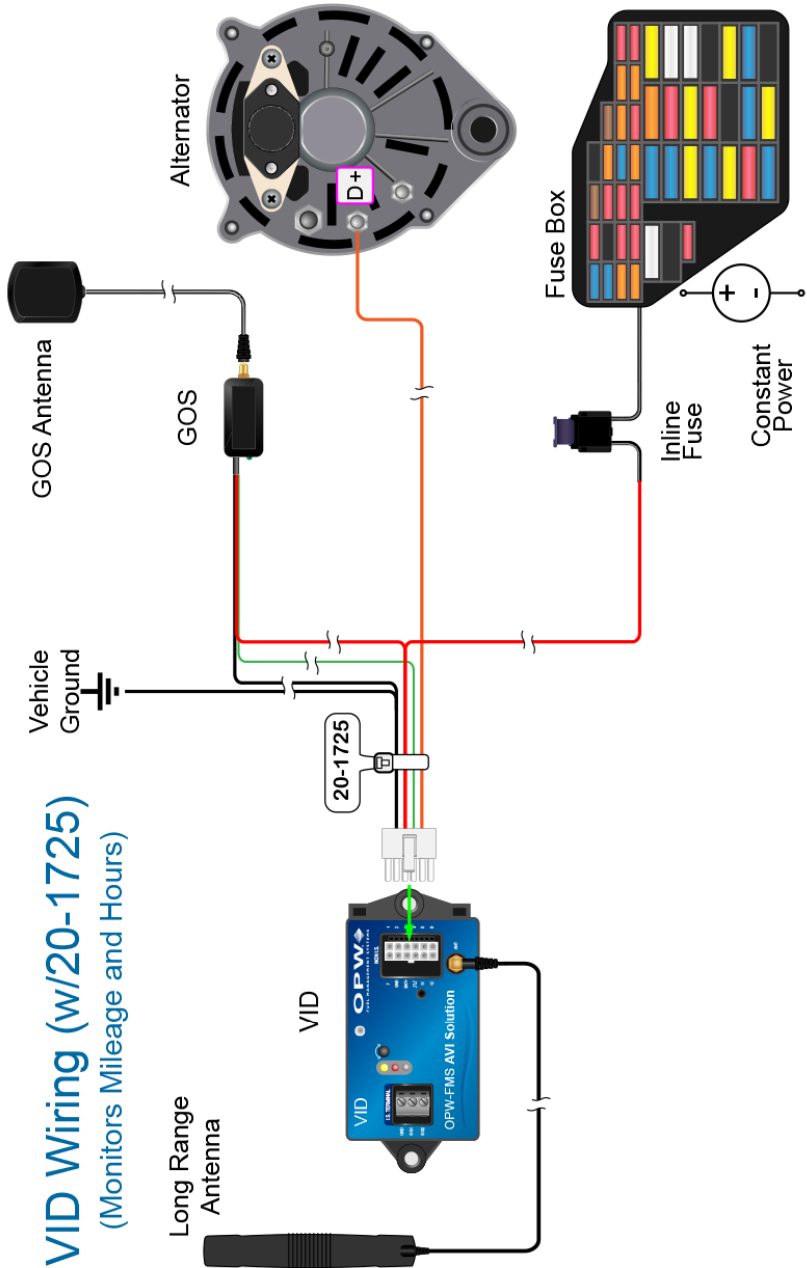

Section 11 Component Test

Do a test of the components with the vehicle at the pump. If a vehicle's components operate correctly, go to the next vehicle.









Make sure to:

- Do a check of each transaction to make sure the tag number is correct.
- For the VID/GOS mileage option, make sure the odometer shows on the transaction.
- For the VID/GOS hours option, make sure the hours show on the transaction.

Do Checks for:

- Disconnect timeouts:
 - Tune the tag again.
- If LEDs do not show or if the RFN connection to VIS is not operational (there is a disturbance):
 - Do a check on the antenna.
 - Relocate the antenna
 - Install an external antenna
- If the VIS does not communicate with FSC:
 - Do a check of the PetroNet connection.
 - Make sure all cable connections on the board are correct and tight.
 - Possibly replace the RS232 to 485 converter.
- Transaction errors (no approvals):
 - Do a check of the fuel permissions for the tag.
 - Do a check of the fuel quantities.
- Pump shut-off during fueling:
 - Do a check of the timers.
- Communication issues:
 - Make sure the metal from the antenna does not touch the metal of the Terminal housing. Use electrical tape to isolate if necessary.

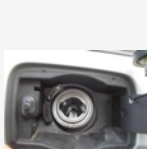
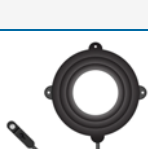
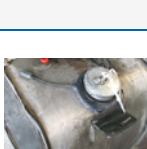
Appendix A - Tag Type Matrix

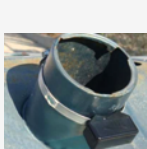
OPW-FMS AVI Tag Type Selection Guide (part numbers are listed below this table)						
Tag Type	Image	Photo	Available Sizes	Self-Destruct	Recommended Applications	Note
Flexible			60mm - 150mm (2.4" - 5.9")	No	Autos Light Duty Commercial	Requires Tag Clips
Flexible with Tail			60mm - 150mm (2.4" - 5.9")	Yes One-way screw included	Long-neck Fuel Inlets	Requires kit with P-clips, P-clip holders and Stainless Steel Band
Mini-Flex			60mm - 130mm (2.4" - 5.11")	Yes One-way screw included	Autos Light Duty Commercial Capless Fuel Inlets (70-80 mm Tag)	For Capless Fuel Inlets No Tag Clips needed
Universal Moon Tag			One-size	Yes One-way screw included	Sedans Light Duty Motorcycles	For applications where space is a factor or other tag types are impractical.
Collar			Three Sizes	Yes One-way screw included	Trucks Buses Commercial Industrial	Requires adhesive
Truck			Side Facing Top Facing	No	Trucks Buses	For long-neck fuel inlets. Requires steel band clamp

OPW-FMS AVI Tag Type Selection Guide (part numbers are listed below this table)

Tag Type	Image	Photo	Available Sizes	Self-Destruct	Recommended Applications	Note
Truck Flex-Mount			One-size	No	Exterior Tanks with Short Fuel Inlets	For exterior tanks with short fuel inlets. Requires two 10mm stainless steel bands
Button			One-size	No	Motorcycles	Use industrial-grade double-sided tape or Pratley Steel Epoxy adhesive.
Wiggins						

Tag Part Numbers

Flexible Tags

- 54-10016010 - 60mm (2.4")
- 54-10016011 - 70 mm (2.76")
- 54-10016012 - 80 mm (3.15")
- 54-10016013 - 90 mm (3.54")
- 54-10016014 - 100 mm (3.94")
- 54-10016015 - 110 mm (4.33")
- 54-10016016 - 115 mm (4.53")
- 54-10016017 - 120 mm (4.72")
- 54-10016018 - 130 mm (5.12")
- 54-10016019 - 140 mm (5.51")
- 54-10016020 - 150mm (5.91")

Flexible Tag with Tail

- 54-10016081 - 60 mm (2.4")
- 54-10016082 - 70 mm (2.76")
- 54-10016083 - 80 mm (3.15")

54-10016084 - 90 mm (3.54")
54-10016085 - 100 mm (3.94")
54-10016086 - 110 mm (4.33")
54-10016087 - 115 mm (4.53")
54-10016088 - 120 mm (4.72")
54-10016089 - 130 mm (5.12")
54-10016090 - 140 mm (5.51")
54-10016091 - 150 mm (5.91")

Mini-Flex

54-10016002 - 60 mm (2.4")
54-10016003 - 70 mm (2.76")
54-10016004 - 80 mm (3.15")
54-10016005 - 90 mm (3.54")
54-10016006 - 100 mm (3.94")
54-10016007 - 110 mm (4.33")
54-10016008 - 120 mm (4.72")
54-10016009 - 130 mm (5.12")

Universal Moon Tag

54-10016032

Collar Tag

54-10016028 - 50 - 90 mm (1.97 - 3.54")
54-10016029 - 50 - 120 mm (1.97 - 4.72")
54-10016030 - 70 - 150 mm (2.76 - 5.91")

Truck Tag

54-10016022 - PCB Antenna Facing Side
54-10016074 - PCB Antenna Facing Top

Truck Mount Flexible Tag

54-10016021

Button Tag

54-10016023

Wiggins Tag

54-1258

Revisions

Revision #	ECO	Effective	Software Version	Key Changes
0	1546	3/22/2019	na	Initial Release
1	TBD	TBD		Added: New SRFN design installation, Tag Type Matrix Appendix, Component Test, Battery Safety Warnings



NOTE: It is possible that older software versions might not support all features

Warranty

OPW Fuel Management Systems warrants that all OPW Tank Gauge and Petro Vend Fuel Control systems supplied by OPW Fuel Management Systems to the Original Purchaser will be free from defects in material and/or workmanship under normal use and service for a period of 12 months from the date of installation or 15 months from the date of shipment from OPW. Additionally, OPW Fuel Management Systems warrants that all upgrades and replacement parts (new and remanufactured) supplied by OPW Fuel Management Systems will be free from defects in material and workmanship under normal use and serviced for a period of 90 days from the date of installation or for the remainder of the system's original warranty, whichever is greater, as set forth in the first sentence of this statement. The foregoing warranties will not extend to goods subjected to misuse, neglect, accident, or improper installation or maintenance or which have been altered or repaired by anyone other than OPW Fuel Management Systems or its authorized representative. The buyer's acceptance of delivery of the goods constitutes acceptance of the foregoing warranties and remedies, and all conditions and limitations thereof.

If a claim is made within the warranted time period that any equipment and/or remanufactured part is defective in material or workmanship under normal use and service, such equipment and/or remanufactured part shall be returned to OPW Fuel Management Systems, freight prepaid. If such equipment or remanufactured part is found by OPW Fuel Management Systems in its sole judgment to be defective in material or workmanship under normal use and service, OPW Fuel Management Systems shall, at its sole option, repair or replace such equipment and/or remanufactured part (excluding, in all instances, fuses, ink cartridges, batteries, other consumable items, etc.) OPW Fuel Management Systems shall not be held responsible for data loss or retrieval on returned products.

The warranties, as set forth above, are made expressly in lieu of all other warranties, either expressed or implied (including, without limitation, warranties of merchantability and fitness for any particular purpose and of all other obligations or liabilities on OPW Fuel Management Systems' part.) Further, OPW Fuel Management Systems neither assumes, nor authorizes any other person to assume for it, any other liability in connection with the sale of the systems, or any new/replacement part that has been subject to any damage from any act of nature or any force majeure. Any terms proposed by the Original Purchaser either orally or in writing are expressly rejected. The terms and conditions expressed in this document may only be changed upon the express written consent of OPW Fuel Management Systems.

The term "Original Purchaser" as used in these warranties shall be deemed to mean the authorized OPW Fuel Management Systems' distributor to which the system or any new/replacement part was originally sold. These warranties may be assigned by the original purchaser to any of its customers who purchase any OPW Fuel Management Systems' systems or new/replacement parts. This document shall be governed by and construed in accordance with the law of the State of Illinois. OPW Fuel Management Systems and Original Purchaser agree that any legal action or proceeding under or with respect to this document may ONLY be brought in the courts of the State of Illinois, or the United States District Court having jurisdiction in the City of Hodgkins, Illinois. Original Purchaser expressly consents to personal jurisdiction in any of the above-mentioned forums and agrees to waive all defenses based on improper venue or inconvenient form should an action be brought therein.

The sole liability of OPW Fuel Management Systems, for any breach of warranty, shall be as set forth above. OPW Fuel Management Systems does not warrant against damage caused by accident, abuse, faulty or improper installation or operation. In no event shall manufacturer's liability on any claim for damages arising out of the manufacture, sale, delivery or use of the goods exceed the original purchase price of the goods. In no event shall OPW Fuel Management Systems be liable for any direct, indirect, incidental or consequential damage or loss of product.

TERMS

Ex-works our factory, Hodgkins, Illinois, USA

Installation not included.

All trade names are registered. Patents pending.

Subject to engineering improvement and/or other changes.



MANY BRANDS. ONE MISSION. YOUR SUCCESS.



Dover Fueling Solutions Global Locations

Corporate Headquarters
3814 Jarrett Way
Austin, Texas 78728
United States
Phone: +1 512 388 8311
www.doverfuelingsolutions.com

North America

Richardson, TX, USA
Hodgkins, IL, USA
Perkasie, Pennsylvania, USA
Brighton, Ontario, CAN

Latin America

Rio de Janeiro, Brazil*

Europe

Dundee, UK*
Skelmersdale, UK
Greenville, FR
Villepinte, FR
Milan, IT

Munich, DE
Bladel, NL
Turnhout, BE
Malmö, SE
Krakow, PL

Asia Pacific

Guangzhou, CN*
Shanghai, CN
Navi Mumbai, IN
Victoria, AU

* Regional Headquarters

OPW Fuel Management Systems • 6900 Santa Fe Dr. • Hodgkins, Illinois, USA 60525 • Tel: (708) 485-4200

DFS *Worldwide Brands*

Wayne